

BIM Essential Guide

For Architectural Consultants



BCA acknowledges the leadership provided by the BIM Steering Committee in support of the production of the BIM Essential Guides

The BIM Essential Guides have been drafted by the Centre for Construction IT on behalf of BCA and the BIM Steering Committee.

©Building and Construction Authority 2013

Building and Construction Authority
5 Maxwell Road
#16-00 Tower Block MND Complex
Singapore 059110
www.bca.gov.sg

First published August 2013

While every effort has been made to ensure the accuracy and quality of information contained in this publication, the Building and Construction Authority, its employees, agents or industry partners can take no responsibility for the subsequent use of this information, nor for any errors or omissions that it may contain.



Cover image and design courtesy of RSP Architects Planners & Engineers (Pte) Ltd and the BCA Academy of the Built Environment.

Contents

CEO's Message	ii
ACKNOWLEDGEMENTS	iii
OBJECTIVES	1
Suggested BIM Deliverables	2
Preparation & Conceptual Design	3
Understanding Client's Requirements	4
Site Model based on Surveyor's / Civil Engineer's Data	6
Conceptual Massing	9
Schematic Design	13
Schematic Model	14
Collaboration with Developers (Design Only)	16
Collaboration with Structural Engineers	17
Detailed Design	19
Detailed Design Model	20
Collaboration with Mechanical, Electrical & Plumbing Engineers	23
Collaboration with Specialist Consultants and Fabricators	26
Tender Documentation	28
Construction	30
Others	31
Value- Added Services	31
Regulatory Submissions	31
Model version control	32

CEO's Message

Dear readers,

Building Information Modelling (BIM) has gained much traction in recent years as digital construction technology that will fundamentally transform the building and construction industry practice in the delivery of an excellent built environment. It is a game changing technology that will improve the construction productivity as well as the level of integration and collaboration across the various disciplines in the construction value chain. It is therefore important for the industry to embrace the technology with clarity.



The BIM Essential Guides are part of the industry's efforts to demystify BIM and to give clarity on the requirement of BIM usage at different stages of a project.

Under the leadership of the BIM Steering Committee chaired by Er Lee Chuan Seng, Emeritus Chairman, Beca Carter, and comprising of leaders in BIM, the BIM Managers Forum has contributed much time and effort to compile the various best practices to make this Guide possible over a short span of time. We would like to thank them for their contribution.

We hope that every BIM user can truly reap the benefits of BIM by integrating it into his/her day-to-day workflow – from feasibility study to facility management. We hope that BIM users can use these guides as a platform to jumpstart their BIM adoption, before they leap to greater heights, innovating and transforming their workflow.

BIM is a journey. We envisage that it will grow with time and will inspire more advanced and innovative use of BIM. I would like to encourage all BIM practitioners to join in this industry effort to grow this Guide into a wealth of BIM knowledge.

Dr John Keung

ACKNOWLEDGEMENTS

BCA would like to acknowledge the contributions of the following organizations which had provided their valuable inputs in the development of this guide:

AEDAS

Architects Vista Pte Ltd

CPG Corp Pte Limited

DCA Architects

DP Architects Pte Ltd

Ong & Ong Pte Ltd

P & T Consultants Pte Ltd

RDC Architects

RSP Architects Planners & Engineers (Pte) Ltd

WOHA

Centre for Construction IT

Grace Lim Yew Lee

Tan Sze Pheng

Mark Ray Delos Santos

Steven Tan

Min Thu

Desmond Tan

Margaret Lau

Wong Hao Jan

Daniels Chandra

Chung Yok May

Kevin Ngin

Loh Ju-Hon

Christine Ho

Garvin Goh Jiayu

Wong Kuan Wei

Richard Kuppusamy

Mary Ann Samaniego

Huang Yixiang

OBJECTIVES

The objective of this Essential Guide is to assist Architects to develop models in their BIM project, including New Construction and A&A Projects. It is a graphical guide that shows the possible use-cases of BIM for various Design Stages of the project.

This is a general document that covers a few typical buildings and not an extensive document that covers all scenarios that might arise based on specific projects. Users are allowed to edit/change accordingly to suit their needs.

This Essential Guide is not based on any particular BIM software and does not cover any explanation or steps on its usage. For help and guide for your specific BIM software, please refer to your software user manual.

Based on the project requirement, type and time line choose the BIM use and implement in the project.

Suggested BIM Deliverables

STAGE	SUGGESTED BIM DELIVERABLES (ARCHITECTURAL ONLY)
1. Preparation & Conceptual Design	<ul style="list-style-type: none"> a. Understanding Client’s Requirements b. BIM Execution Plan (as one of the parties involved in the BIM project) c. Site Model based on Surveyor's / Civil Engineer's Data d. Conceptual Massing Model
2. Schematic Design	<ul style="list-style-type: none"> a. Preliminary Model b. Preliminary Design Coordination Report between Architecture model & Structural model
3. Detailed Design	<ul style="list-style-type: none"> a. Detailed Design model, with input from specialist consultants b. Clash detection & resolution report between Architecture, Structure & MEP models c. Tender documents
4. Construction	a. RFI Resolutions
5. As Built	N/A
6. Facility Management	N/A

Note: Regulatory BIM e-submissions are excluded from the above list because the timing of submission may vary due to individual project requirements.

Preparation & Conceptual Design

An example process workflow in the Preparation & Conceptual Design stage:

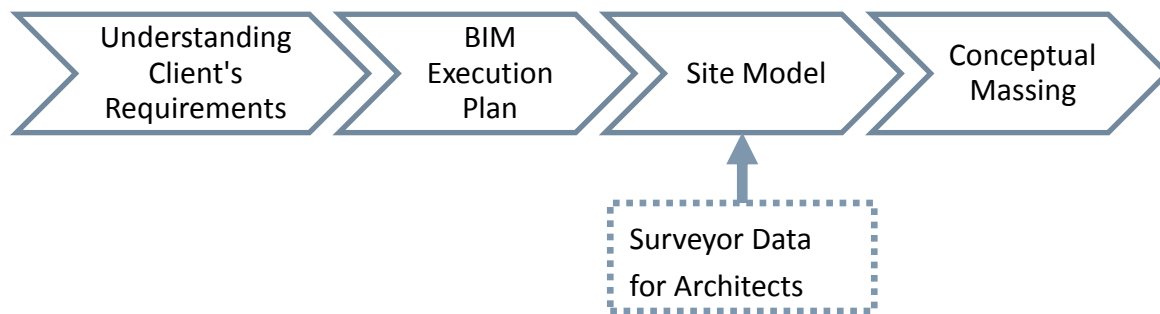

SUGGESTED DELIVERABLES

ELEMENTS	USED FOR
Topography (Existing Site Model), Topography (Proposed Site Model), Property/ Boundary Lines	<ul style="list-style-type: none"> • Establish existing site conditions • Site study and analysis
Massing (Building Model)	<ul style="list-style-type: none"> • Areas and Volumes Calculation • Design Alternatives • Early Energy Analysis • Sustainability Aspirations
3D Images / Artist's Impressions	<ul style="list-style-type: none"> • Conceptual Visualization

UNDERSTANDING CLIENT'S REQUIREMENTS

- Identify project brief
- Identify sustainability aspirations

Both the client and the architect should reach an understanding on the purpose of BIM to fulfil Client's Requirements.

Example of some questions that can be asked to understand the Client's Requirements.

- What are the overall goals in this BIM project?
- What are the specific goals that have to be achieved by BIM in this BIM project?
- What are the possible ways to achieve the specific BIM goals?
- Is the client aware and agreeable that the design team may use a different way to achieve the specific BIM goals?

The Client's Requirements could be fulfilled by BIM, non-BIM or hybrid methods, depending on the goals and constraints of the project, as well as the practices and resources of the architect's firm (see facing page).

Example of BIM, non-BIM or hybrid methods used to fulfil milestones in a BIM project
 (Source: RDC Architects Pte Ltd, for a HDB project, 2011)

Current Process – Process in CAD

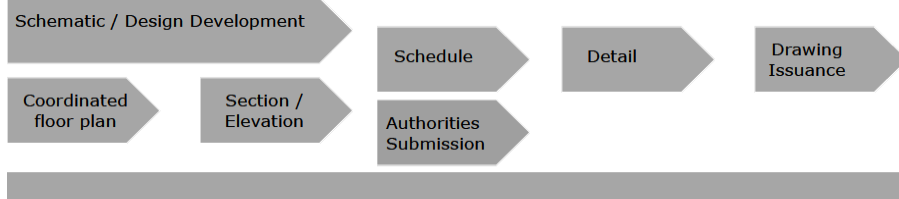

Our BIM Process

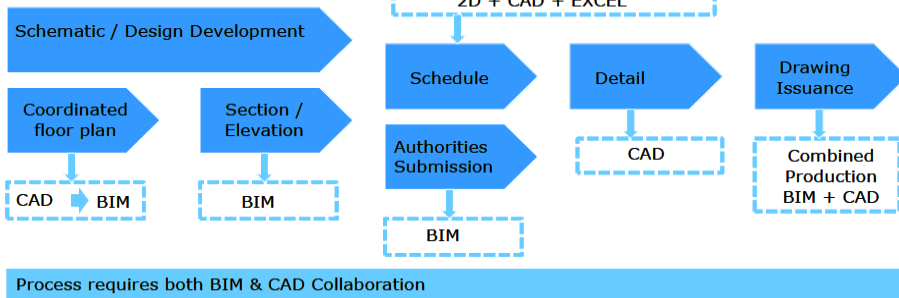

Example of BIM and hybrid methods used to fulfil milestones in a BIM project
 (Source: RSP Architects)

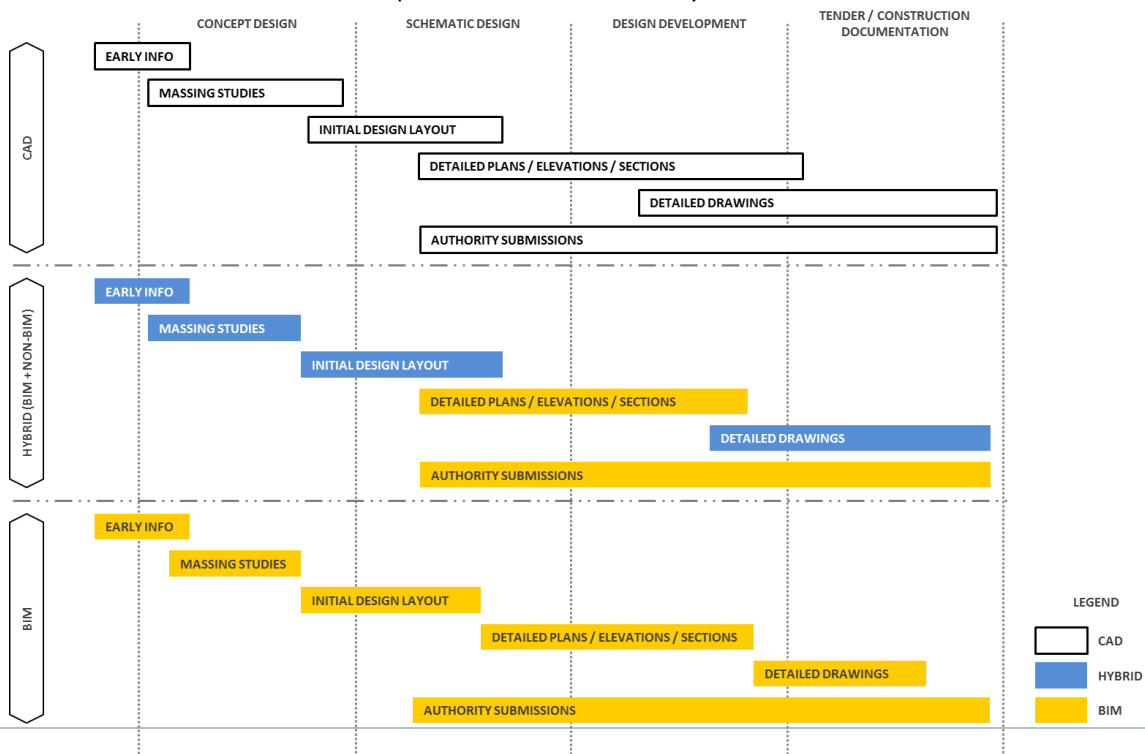

SITE MODEL BASED ON SURVEYOR'S / CIVIL ENGINEER'S DATA

- Produce topography and site context model

Collaboration with Registered Surveyors/ Civil Engineers takes place on the Conceptual Design Stage. Registered Surveyors/ Civil Engineers play an essential part in starting a BIM Project. Pre-requisite information which is vital to the project is handed over to the Architects before proceeding to kick- off the BIM project.

	INPUT FROM OTHER DISCIPLINE	DELIVERABLES / OUTPUT FROM ARCHITECTURAL MODEL
Registered Surveyor	<ul style="list-style-type: none"> • SVY21 Coordinate system and with reference to the SLA Vertical Control Point (VCP) plus 100m • Surveyors Point 	<ul style="list-style-type: none"> • Accurate X, Y, Z coordinates • Ground Level
	<ul style="list-style-type: none"> • Boundary Lines 	<ul style="list-style-type: none"> • Boundary Lines
	<ul style="list-style-type: none"> • Existing Site Conditions 	<ul style="list-style-type: none"> • Topography (Existing Site Conditions)
Civil	<ul style="list-style-type: none"> • Adjacent Road • Adjacent Properties • Existing Utilities 	<ul style="list-style-type: none"> • Adjacent Road • Adjacent Properties • Utility Layout

To generate the topography model, the Architect will use topography drawings of the existing site, provided by the Registered Surveyor / Civil Engineers.

In the topography drawings, layers containing 3D point data (with Z-coordinates) should not contain stray 2D point data. This will save time for the Architect, who would otherwise have to spend time cleaning up drawing layers before they can use the data for creating the site model.

For higher accuracy, surveyors can create a terrain model in TIN (Triangular Irregular Network) surfaces before the Architect converts the TIN surfaces into a BIM topography surface.

*Topography model: TIN conversion to BIM format
(Credits: Singapore Land Authority, BCA Academy)*

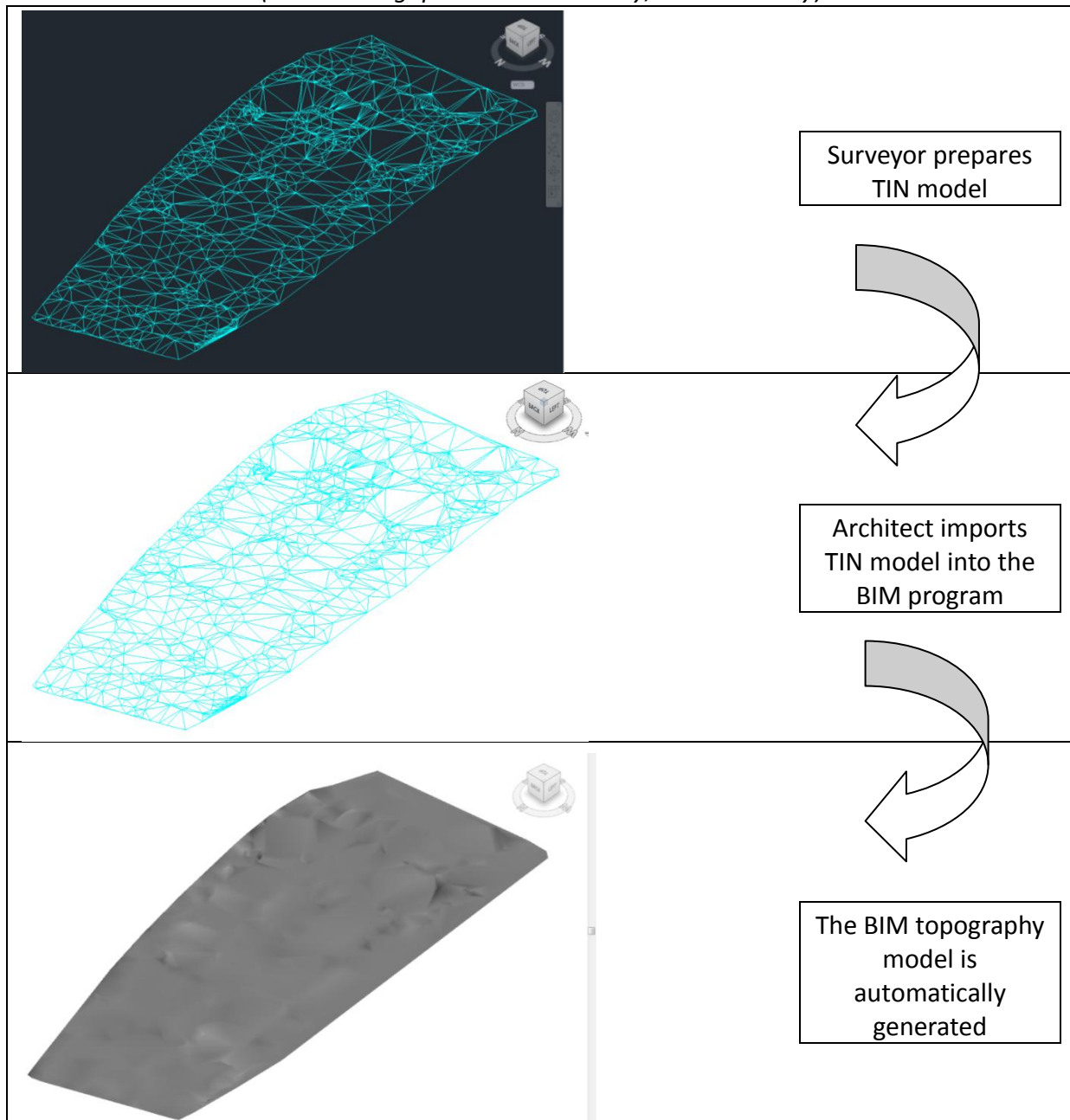

NOTE:

Architects must set out the shared coordinates from the surveyor data. This shared coordinates must be agreed by all project parties and recorded in the BIM Execution Plan.

Grids and levels can be set out on the site model to begin on the sketch massing options.

Grids and levels set up on the site model

(Source: 3PA International)

(Project: Telok Blangah Soka Centre; Owner: Singapore Soka Association)

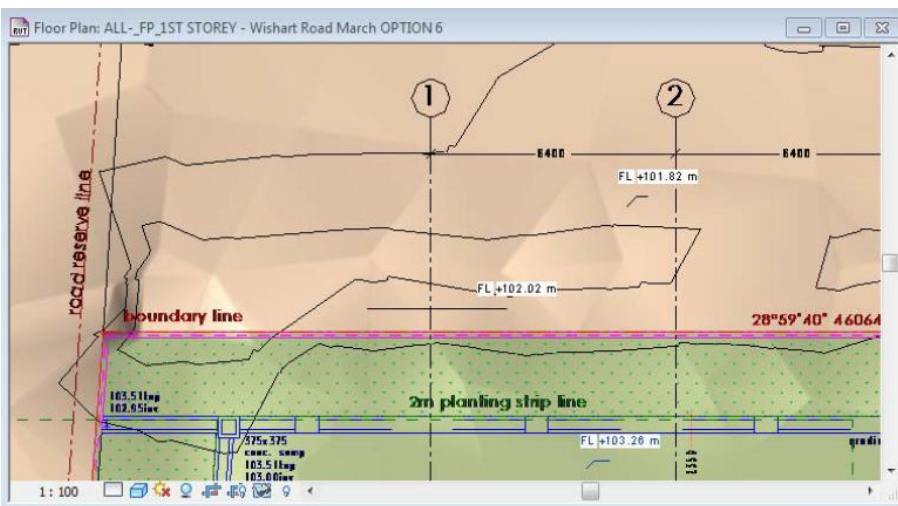

(left) Site plan view

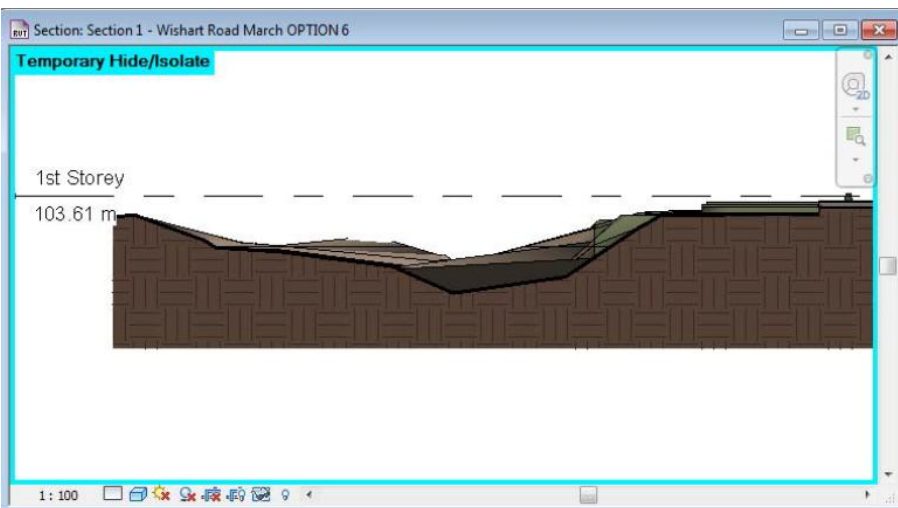

(left) Section view

CONCEPTUAL MASSING

- Produce conceptual massing model
- Test and validate design brief area schedule

Conceptual Massing consists of building massing studies or other forms of data representation with indicative dimensions, area, volume, location and orientation.

*Conceptual Design Model and Information requirements
(Adapted from source: Ong & Ong Pte Ltd)*

- Existing conditions (e.g. site topography, existing building, etc.)
- Site location information, longitude, latitude, true north orientation
- Massing, form and shape
- Property boundaries
- Space, zone and rooms
- Level and height information
- Opening, solid, void and transparent definitions
- Other conceptual design related model(s) as required

BIM METHOD

Example of Conceptual Massing
(Source: 3PA International)
(Project: Telok Blangah Soka Centre; Owner: Singapore Soka Association)



Early environmental simulation for BIM Massing can also be carried out at the early design stages.

Example of Sun Studies

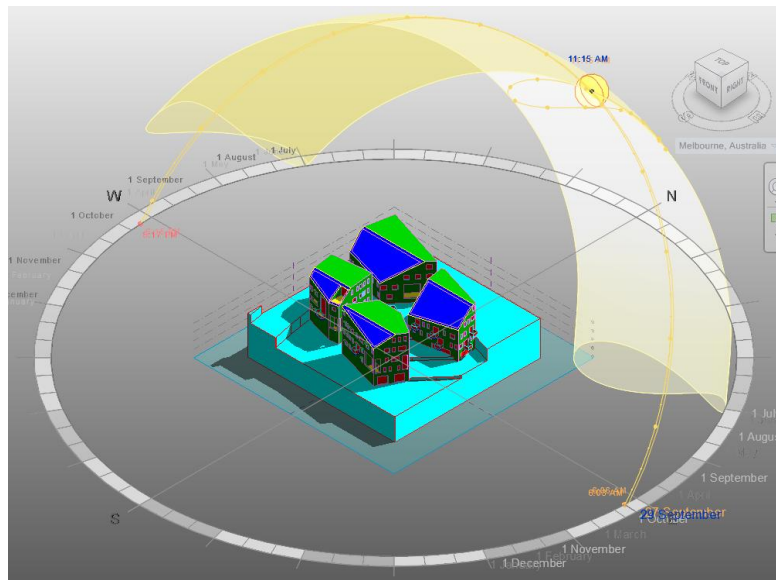

Massing can also be used to quantify key metrics (area, perimeter, volume) for each level. By scheduling mass floor areas, the architect can instantly test and validate various area schedules to satisfy the client’s design brief requirements.

Example of massing floor area schedules

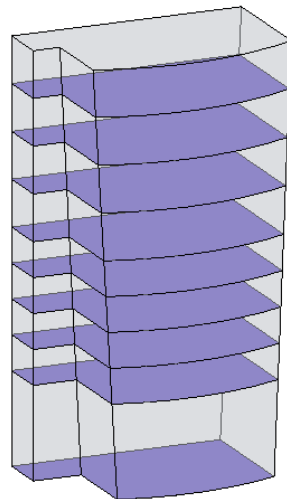

Mass Floor Schedule				
Level	Floor Area	Floor Perimeter	Floor Volume	Exterior Surface Area
Level 1	107 m ²	591.24	1524.72 m ³	416 m ²
Level 2	194 m ²	597.03	596.94 m ³	190 m ²
Level 3	197 m ²	599.17	595.13 m ³	190 m ²
Level 4	200 m ²	603.29	603.27 m ³	181 m ²
Level 5	202 m ²	603.39	611.36 m ³	181 m ²
Level 6	205 m ²	605.48	627.61 m ³	243 m ²
Level 7	209 m ²	608.24	641.73 m ³	244 m ²
Level 8	212 m ²	610.96	655.72 m ³	245 m ²
Level 9	216 m ²	613.65	664.81 m ³	464 m ²
Grand Total:	1822 m ²	5430.46	7311.28 m ³	2393 m ²

NOTE:

The tool used for design massing should not be limited to BIM only. Hand sketches, 3rd party modelling software, etc can be used before translating design options into BIM models.

Google Sketch-Up imported to Revit

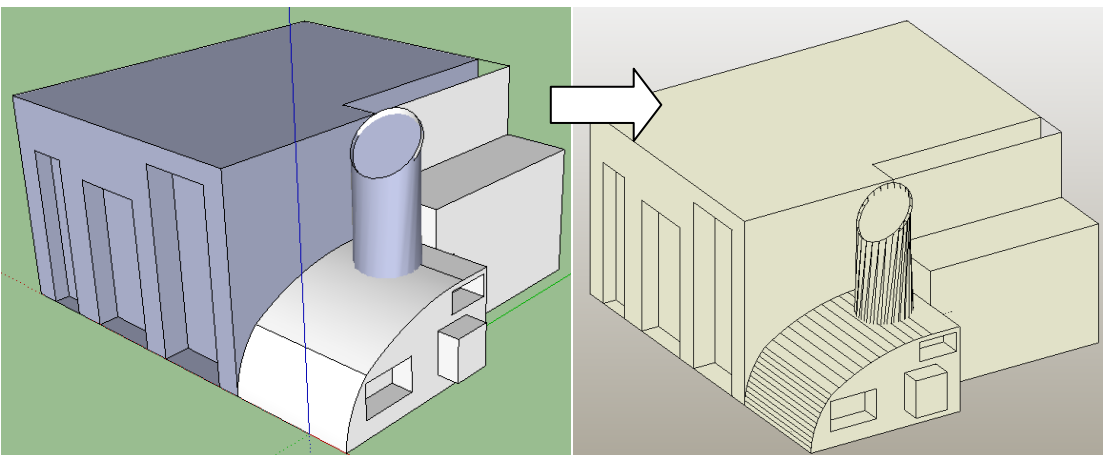

Rhino imported to Archicad

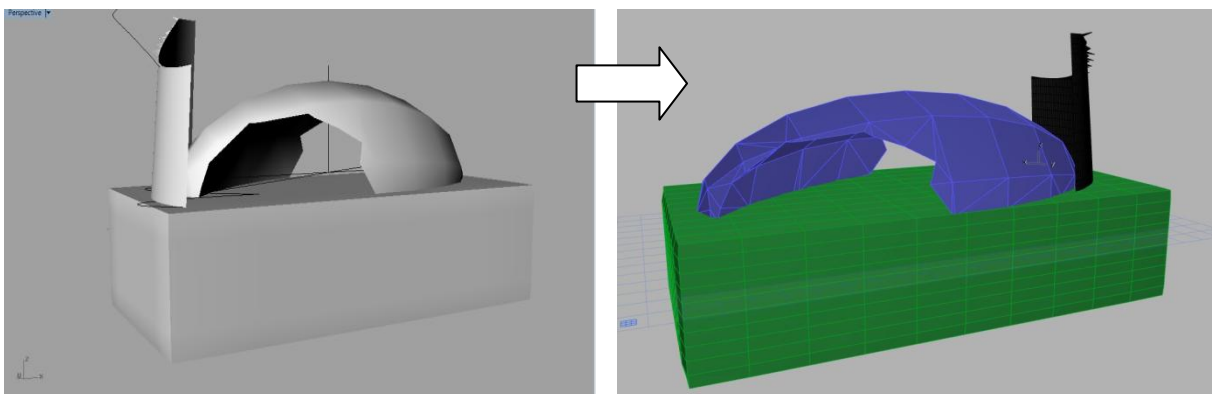

Schematic Design

An example process workflow in the Schematic Design stage:

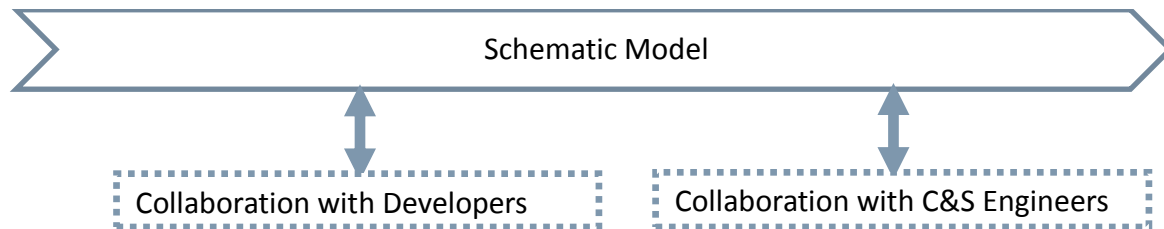

SUGGESTED DELIVERABLES

ELEMENTS	USED FOR
Generic Building Components <ul style="list-style-type: none"> • Wall • Column (can be included in the ST model) • Slab / Floor • Door • Window • Roof • Staircase • Ceiling • Fixtures • Furniture Items • Others (Façade treatment, railing etc) 	<ul style="list-style-type: none"> • In preparation for regulatory submission (WP, PP) • MEP to do sizing of ceiling plenum services • Remaining floor area calculation • Project-specific e.g. FM-intensive projects such as healthcare and hospitality services • Renderings and visualization for analysis
Building Quantity Schedule	<ul style="list-style-type: none"> • Preliminary Cost Estimates
Space Group (Zone or Space or Room Object)	<ul style="list-style-type: none"> • Area Calculation
Individual Space (Space or Room Object)	<ul style="list-style-type: none"> • Room Calculation
* Preliminary Structural Model	<ul style="list-style-type: none"> • Early AR-ST Coordination
** Preliminary MEP Model	<ul style="list-style-type: none"> • Early AR-MEP Coordination

* produce by Structural Consultant

** produce by MEP Consultants

SCHEMATIC MODEL

- Use conceptual massing model to validate sustainability aspirations
- Produce schematic design layout plans 1:200 scale. Generic wall / window / door components.
- Outline structural and mechanical design

The schematic design model consists of generalized building components or systems with approximate dimensions, shape, location, orientation, and quantity. Non-geometric properties may be provided.

Schematic Design Model and Information requirements (Adapted from source: Ong & Ong Pte Ltd)

- Wall
- Slab / floor
- Door
- Window
- Architecture column
- Ceiling
- Roof
- Space, zone and rooms
- Furniture items
- Other custom objects as required

*Area plan and schedule required during PP BIM e-Submission
 (Source: SAA Architects Pte Ltd
 Project: Parkland Residences; Owner: Low Keng Huat (S) Limited)*



URA-_LV_SUMMARY OF GROSS FLOOR AREA (GFA)

Bk No.	Storey	GFA (m2)	Breakdown of Gross Floor Area (m2)			
			Commercial_Area	Residential_Area	Hotel_Area	Industry_Area
475A		22565.63 m ²	0.00 m ²	22565.63 m ²	0.00 m ²	0.00 m ²
475B		15312.26 m ²	224.71 m ²	15087.55 m ²	0.00 m ²	0.00 m ²
475C		15215.78 m ²	375.40 m ²	14840.38 m ²	0.00 m ²	0.00 m ²
475D		22471.68 m ²	0.00 m ²	22471.68 m ²	0.00 m ²	0.00 m ²
E-DECK	1ST STOREY	104.45 m ²	0.00 m ²	104.45 m ²	0.00 m ²	0.00 m ²
MSCP		943.24 m ²	500.08 m ²	443.16 m ²	0.00 m ²	0.00 m ²
PAVILION	1ST STOREY	199.68 m ²	0.00 m ²	199.68 m ²	0.00 m ²	0.00 m ²
Grand total: 1081		76812.71 m ²	1100.19 m ²	75712.52 m ²	0.00 m ²	0.00 m ²

COLLABORATION WITH DEVELOPERS (DESIGN ONLY)

At the early stage of design, Developers may get involved in the BIM process. By looking at the architecture model in different perspectives, BIM may help them analyze, predict and decide outcomes that usually done during construction of the project.

*Example of Design Issues
(Source: MKPL Architects
(Project: Marine Parade; Owner: CapitaLand)*

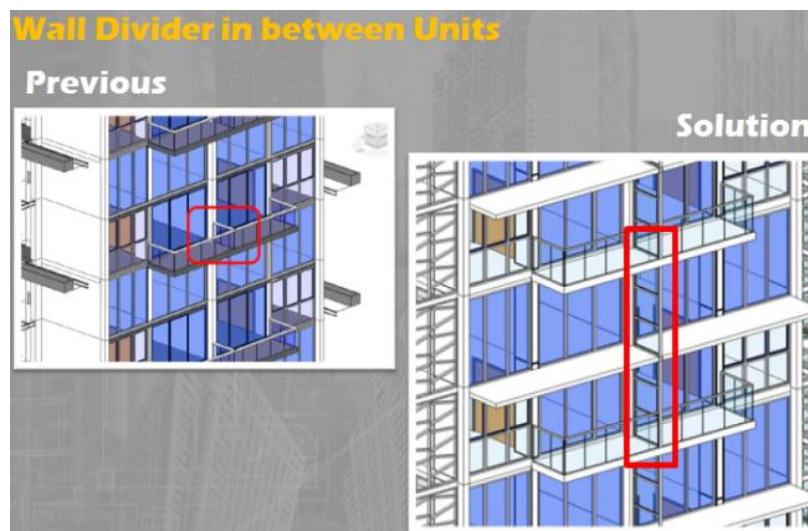

Security Issue on Adjacent Residential Unit

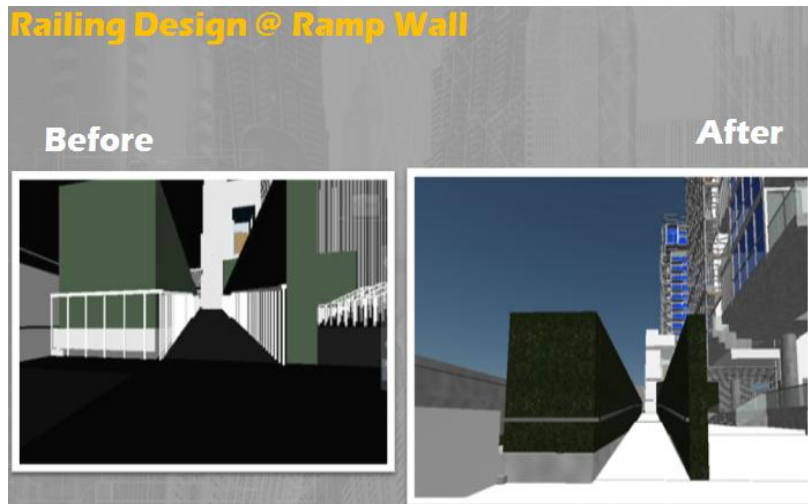

Railing Design Issue

COLLABORATION WITH STRUCTURAL ENGINEERS

- Collaborate and coordinate structural design using BIM

Collaboration between Architects and Structural Engineers take place from Schematic/ Preliminary Design Stage. Model Exchange is done continuously as the design and project progresses. Early clash detections are performed to lessen conflict of elements even before construction.

ARCHITECTURAL MODEL VALIDATION

Architecture model to be linked must be placed at the same coordinates. The basic elements required from the Architectural model for C&S model are as listed

Adapted from BIM Essential Guide for C&S

- X,Y,Z Coordinates
- Grid
- Level
- Column Position
- Wall Position
- Lift Position
- Stair Position
- Ceiling
- Cladding
- Room/ Area
- Landscaping (with soil depth/ planter size, location)
- Surface drainage
- Slab/ Floor Opening
- Sloped floor and ramp
- Precast / GRC facade
- Large hanging lighting fixture
- Building maintenance system (e.g. Gondola)

AR-ST Combined model

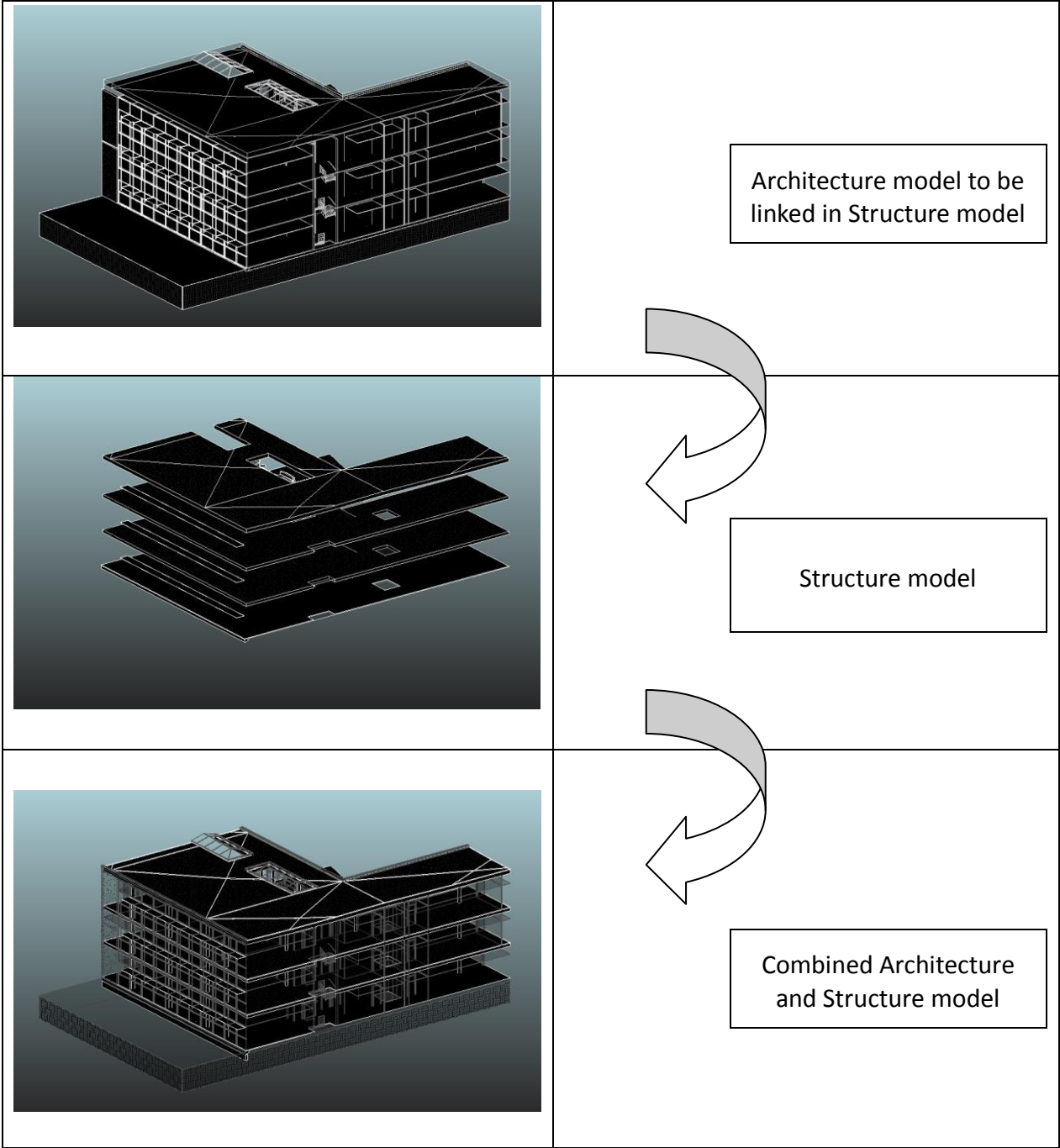

Detailed Design

An example process workflow in the Detailed Design stage:

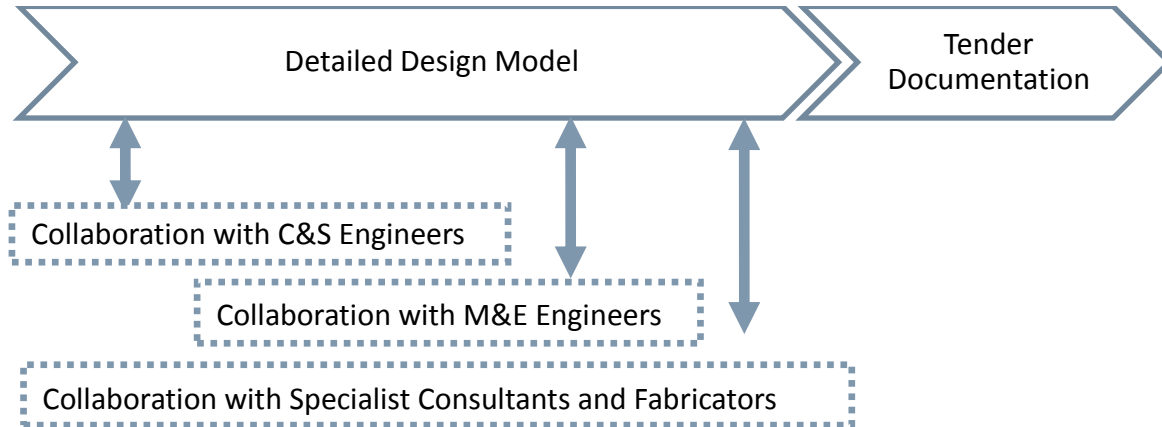

SUGGESTED DELIVERABLES

ELEMENTS	USED FOR
Developed / Detailed Building Components <ul style="list-style-type: none"> • Wall • Column • Slab / Floor • Door • Window • Roof • Staircase • Ceiling • Fixtures • Furniture Items • Others (Façade treatment, Railing etc) 	<ul style="list-style-type: none"> • Building Plan Approval • Tender Documentation
Material take-off and scheduling of building components	<ul style="list-style-type: none"> • Quantity Calculation and Costing
* Preliminary Structural Model	<ul style="list-style-type: none"> • AR-ST Coordination
** Preliminary MEP Model	<ul style="list-style-type: none"> • AR-MEP Coordination

* produce by Structural Consultant

** produce by MEP Consultants

DETAILED DESIGN MODEL

- Produce detail design layout plans showing layer construction 1:100 – 1:50 scale
- Produce 1:20 – 1:5 detail drawings

The detailed design model is a more detailed version of a generalized building component or system with accurate dimensions, shape, location, orientation and quantity. Non-geometric properties should be provided.

*Detailed Design Model and Information requirements
(Adapted from source: Ong & Ong Pte Ltd)*

- Wall
- Slab / floor
- Door & opening
- Window & louver
- Curtain wall
- Column
- Beam
- Staircase / step / ramp
- Ceiling
- Roof
- Furniture
- Other custom objects as required

Modelling detail should be 1:100, where elements whose dimensions are less than 50mm will not be shown.

(Source: Architects Vista Pte Ltd)
(Project: Spectra Secondary School; Owner: MOE)

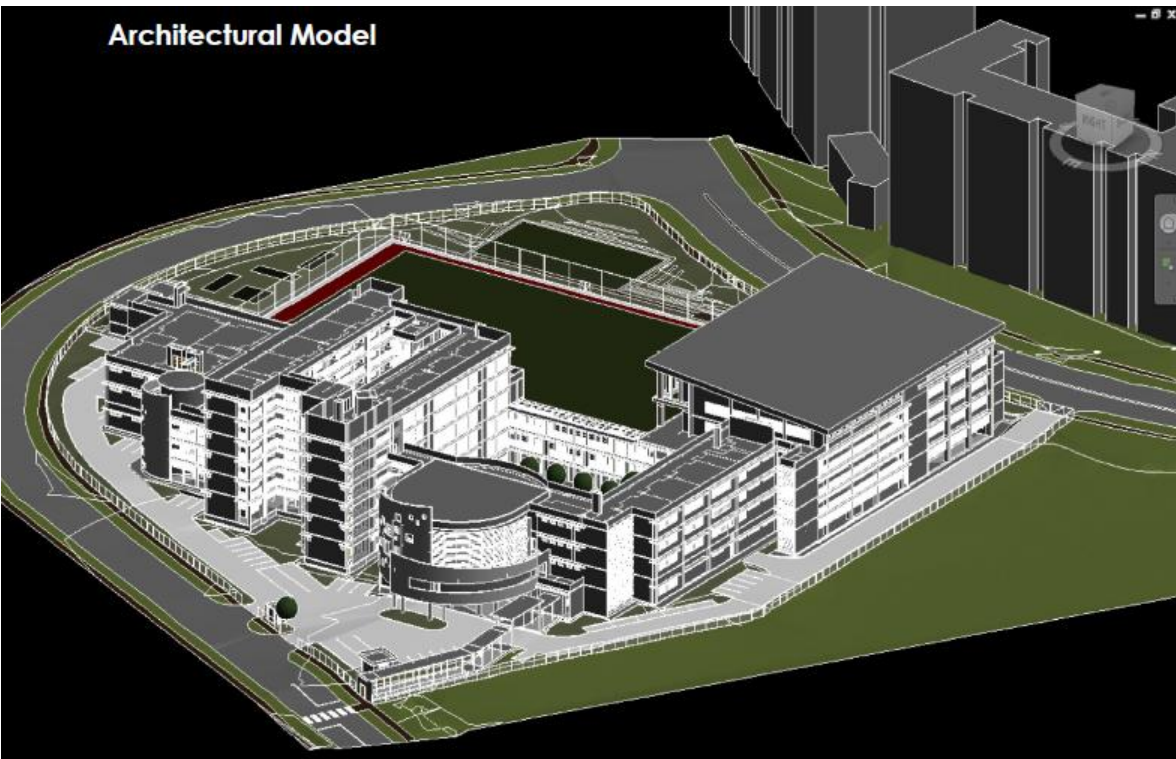
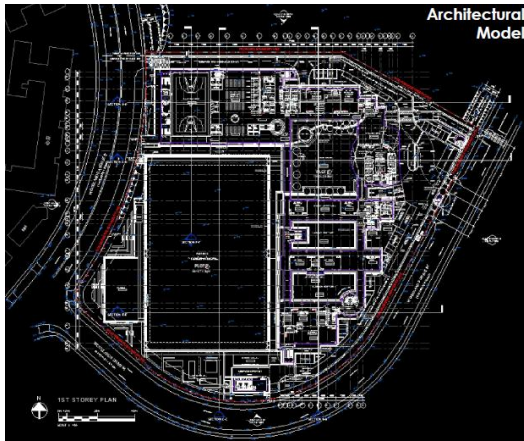

When the Architectural model has undergone its final coordination with the other discipline models, it is ready to extract quantities from the final design model. This BIM meta data is useful for material take off and scheduling of components.

*(Source: RDC Architects Pte Ltd
Project: Anchorvale; Owner: HDB)*

Sample Data - Schedule (BIM 2D + CAD + EXCEL)

The image illustrates the process of extracting data from a BIM model. It shows a 3D BIM model of a building, a 2D elevation drawing of a railing with technical specifications, and an Excel spreadsheet titled 'RAILING SCHEDULE' with columns for room numbers and quantities. The drawing includes specifications such as 'TENSILE TWIN GALVANISED STEEL RING TOP RAIL IN PAINT FINISH TO SPECIFICATION COLOUR TO S.O'S SELECTION', '40UP TWIN COIL WOUND STEEL FLAT BAR', 'PAINT FINISH TO SPECIFICATION COLOUR TO S.O'S SELECTION', and '100 HIGH KERB TO ENGR'S DTL'. The Excel spreadsheet has columns for room numbers (R001 to R010) and quantities for various railing components.

Elevation of building elements was extracted from BIM model. 2D annotations were added & quantities collated in Microsoft Excel sheet for Schedule Drawings.

COLLABORATION WITH MECHANICAL, ELECTRICAL & PLUMBING ENGINEERS

- Collaborate and coordinate MEP design using BIM

Collaboration between Architects and MEP Engineers take place during Detailed Design Stage. Model Exchange is done continuously as the design and project progresses. Early clash detections are performed to lessen conflict of elements even before construction.

ARCHITECTURAL MODEL VALIDATION

Architecture model to be linked must be placed at the same coordinates. The basic elements required from the Architectural model for MEP model are as listed

Adapted from BIM Essential Guide for MEP

- X,Y,Z Coordinates
- Grid
- Levels
- Slab / Floor
- Raised Floor
- Stair Position
- Wall
- Ceiling
- Shaft Location
- Plumbing Fixtures

Example of AR-MEP Combined model

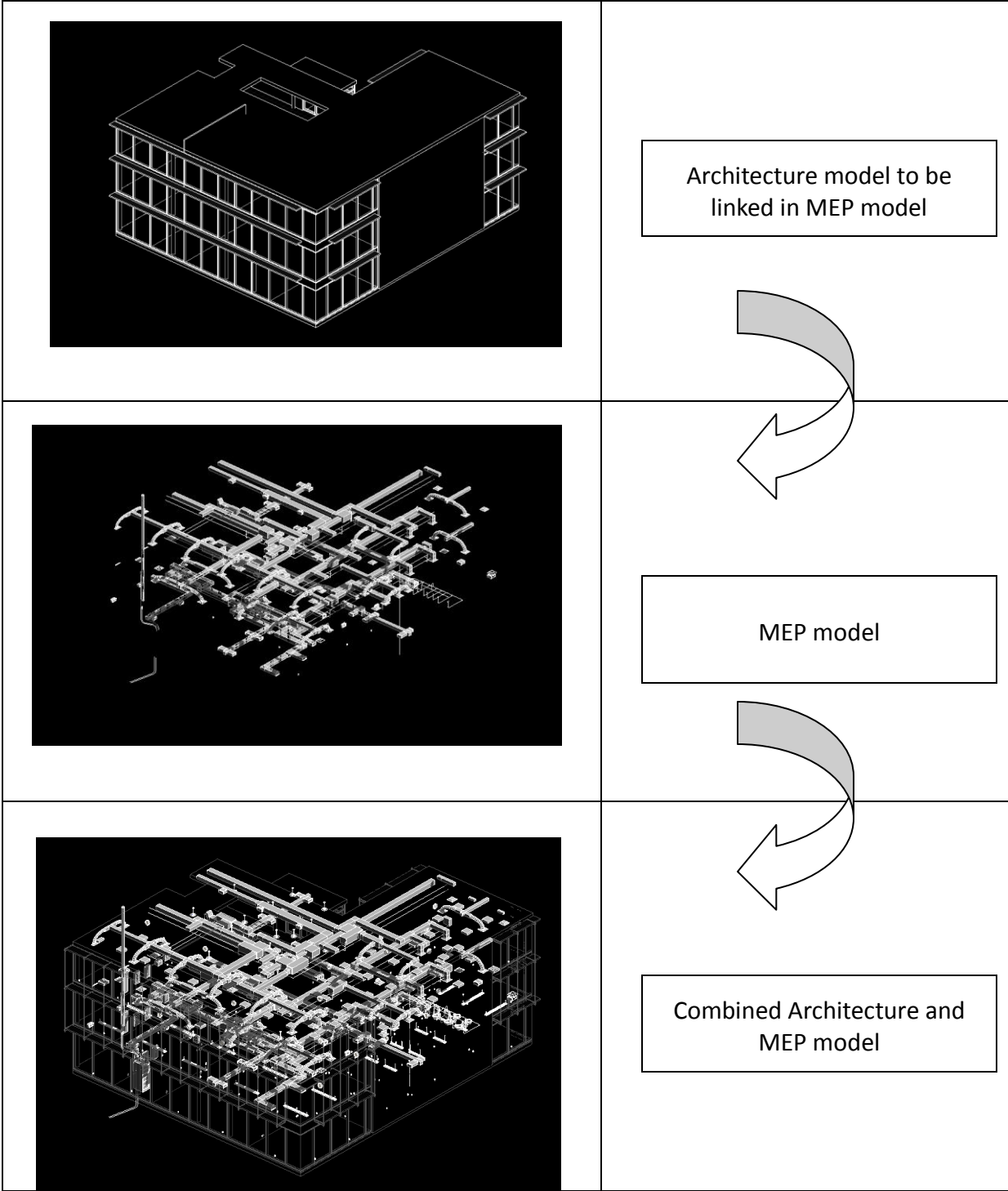

*Example of Model Coordination report
(Source: RSP Architects
Project: BCA Academy & Workshop Block; Owner: BCA)*

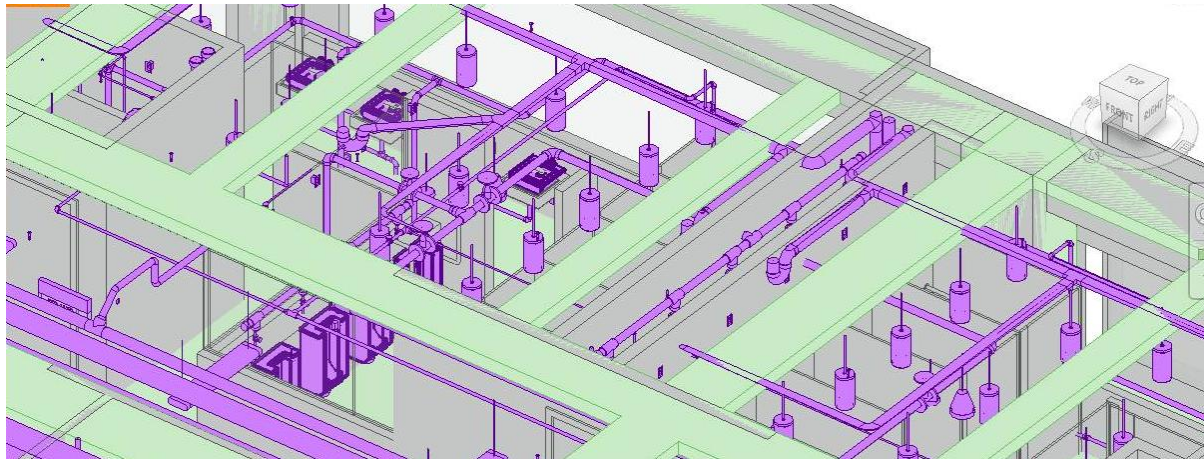

CLASH DESCRIPTION	LOCATION / LEVEL / GRID	TO TAKE NOTE	DATE TO COMPLETE	REMARKS
Louvre Panel at Genset room to be removed away	Level 1 Grid 1-C to 2-B	M&E	03 Aug 2012 Friday	

RSP MODEL COORDINATION REPORT

PROJECT NO. : Q15A1
 PROJECT NUMBER : BCA ACADEMY & WORKSHOP BLOCK
 DATE : 31 JULY 2012
 MODEL USED : ARCHI MODEL 30 JULY 2012
 STRUCTURAL MODEL 31 JULY 2012
 M&E MODEL 19 JULY 2012

LEGEND

Archi Model Components

M&E Model Components

Structural Model Components

NOTES:

COORDINATION MEETING HAS COVERED MUCH AREAS ON THE WITHIN THE RISERS FOR THE TOILETS. CONSULTANTS ARE TO E MEETING, EVEN IF THE ISSUES ARE NOT CAPTURED IN THIS MO

CLASH DESCRIPTION

Sanitary fittings and / structural need to be re-configured based on coordination meeting on 31 July

Worksets

COLLABORATION WITH SPECIALIST CONSULTANTS AND FABRICATORS

- Review BIM input from specialist consultants or fabricator portions

Collaboration between Architects and Specialist Consultants/Sub- Contractors/ Fabricators takes place during Schematic/ Preliminary Design Stage.

ARCHITECTURAL MODEL VALIDATION

Depending on which Specialist/ Sub- Contractors/ Fabricators the Architecture model will pass through, the basic elements in Architecture model should be as listed:

- Element's Plan location
- Element's Quantity Schedule (optional)
- Element's Proposed size (optional)
- Element's Specification (optional)

Example of Specialist Contractor's detailed drawing and master schedule

(Source: Trussco Pte Ltd)

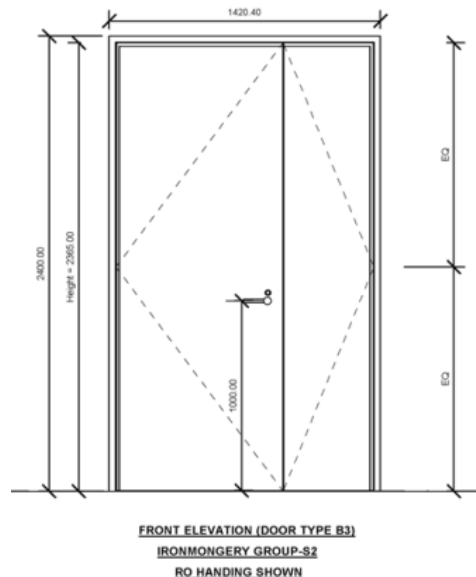

TENDER DOCUMENTATION

- Produce tender and call building tender for continuing BIM collaboration
- Rendering and simulations for marketing purposes

Sample of Typical Unit Finishes Layout
(Source: HDB)

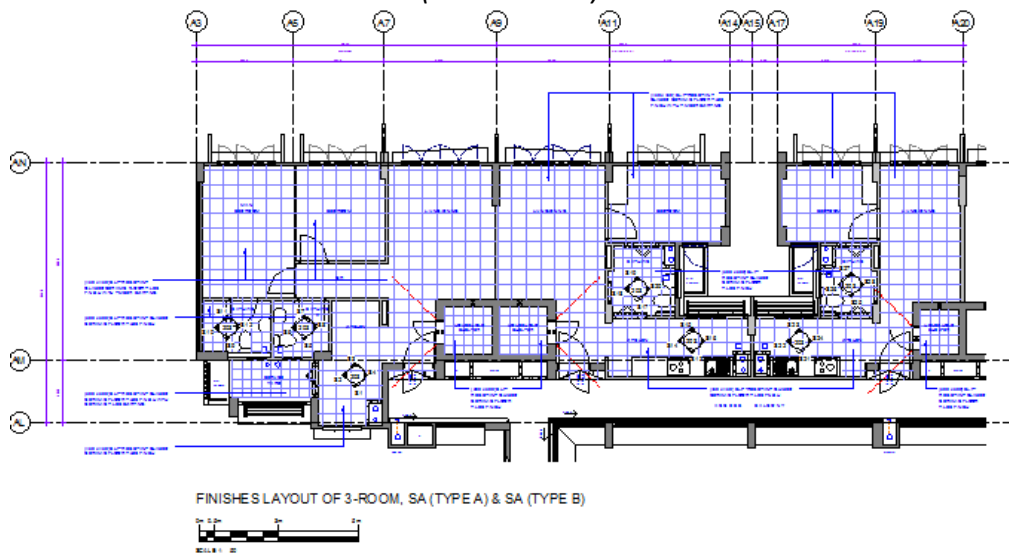

Sample of Bath WC Detailed Elevation
(Source: HDB)

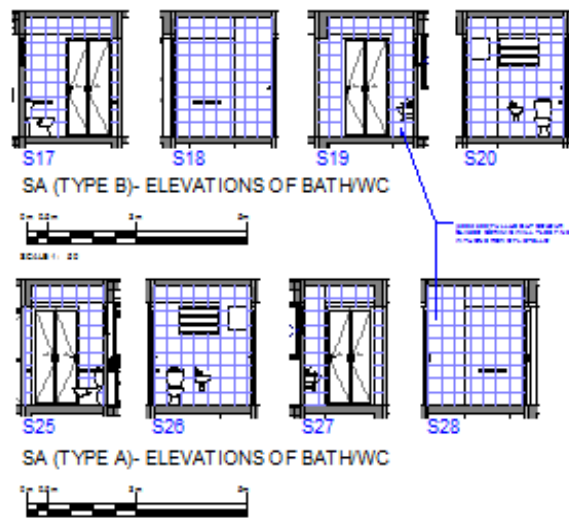

*Example of BIM-generated renderings for marketing purposes
(Source: 23.5 Degree G-Architects Pte Ltd
Project: Grove Residence; Owner: Savoy Development Pte Ltd)*



Construction

- RFI Resolutions

Collaboration between Architects and Contractors take place during Construction Stage. For detailed information, refer to BIM Essential Guide for Contractors

ARCHITECTURAL MODEL VALIDATION

When decided to continue and develop Architecture model to Contractor's model, basic elements required from the Architecture model are as listed

Adapted from BIM Essential Guide for Contractors

- X, Y, Z Coordinates
- Topography (Existing Site Model)
- Topography (Proposed Site Model)
- Grid
- Level
- Building components: Wall, Architectural Column, Door, Window, Slab/ Floor, Ceiling, Fixtures, Furniture (optional), Facade, Railing, etc.

Others

VALUE- ADDED SERVICES

*For detailed information, refer to **Singapore BIM Guide***

REGULATORY SUBMISSIONS

*For detailed information, refer to **BIM Submission Guideline***

MODEL VERSION CONTROL

As the project progresses, consequently is the model change. Model will change according to specific requirements needed in every stage. Few factors of having numerous model versions are as follows:

- Design Change
- Authority Submission and Re-submission
- Model Update
- Remote Office Locations

Different model versions are certain. Managing these versions is the possible option that we may implement to avoid having it. Few recommendations listed below will help all project members to avoid confusion.

Organized Folder Structure

- To implemented office-wide.
- Saving the specific file on their corresponding location will be helpful for all, and will also reduce the time spent in searching.
- To avoid duplicating files on their own PC to avoid confusion when working.
- “Backup”, “Superseded” or similar folder name where all backups/ outdated files are located.
- “Archive”, “Published” or similar folder name where all copies of issued files are located.
- “Working”, “WIP” or similar folder name where only “one working model” (varies on project setup) is located.

Keeping “One Working Model”

- Project Server to serve as a central location of model, where every team member can access and work.
- “Graphisoft BIM Server”, “Revit Server” or similar will allow two or more teams located in remote office locations to update their changes to one central file simultaneously.

NOTE: RECOMMENDATIONS ARE NOT APPLICABLE TO ALL. THESE VARY DEPENDING ON PROJECT AND OFFICE REQUIREMENTS.

This guide is part of the BIM Essential Guide Series

BIM Essential Guide	FOR EACH BIM PROJECT		FOR EACH ORGANIZATION
	WITHIN EACH DISCIPLINE	ACROSS MULTIPLE DISCIPLINES	ALL DISCIPLINES
For Architectural Consultants	●		
For C&S Consultants	●		
For M&E Consultants	●		
For Contractor	●		
For BIM Execution Plan		●	
For BIM Adoption in an Organization			●



Building and Construction Authority
5 Maxwell Road
#16-00 Tower Block MND Complex
Singapore 059110
www.bca.gov.sg

For more information and feedback on the BIM Essential Guide Series, please visit the following blog:
bimsg.wordpress.com

